

# Inclined and Rectangular Hoods with Motor – Instructions Manual

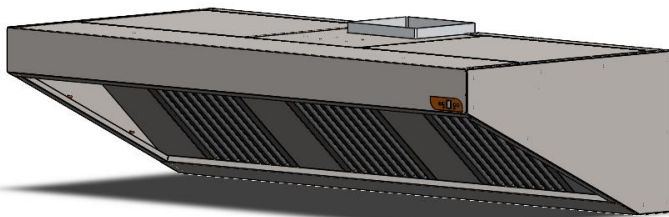

## SYMBOLS UTILIZED IN THIS MANUAL

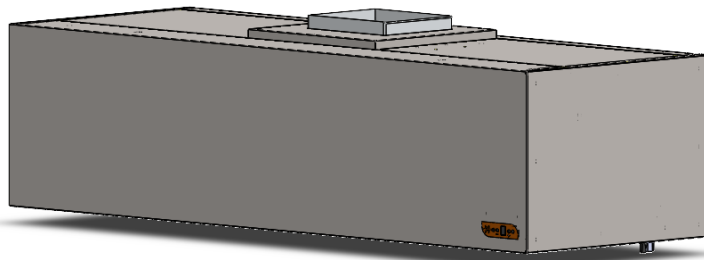

Read the instructions before using the equipment.



Important Safety Instructions. Hazard Risk in case of no compliance.



*Useful guideline for the user.*



Instructions for certified technician only.

## 1. Safety and Appropriate Use

### 1.1. Safety Instructions

The equipment is safe to use and complies with the European safety norms in Effect. However, the inappropriate use can lead to personal injuries and material damage. To insure a correct and safe functioning, please read this manual before first use. This manual contains important warnings about installation, safety, usage and maintenance required by this equipment.

Keep this manual for future reference. Deliver the manual along with the equipment in case of passing it to a new owner.

The manufacturer cannot be held accountable by damages resulting of inappropriate use and installation. Please note that the instructions of this manual do not substitute the technical characteristics engraved in the characteristics plate fixed on the equipment.



**Read carefully the safety instructions!**



**Ensure sufficient ventilation in the room where the Canopy is being used at the same time with gas/other fuels burning equipment.**



The installation and maintenance interventions must comply with the regional and national norms in Effect.



While installing the equipment make sure the weight is distributed evenly by every fixing point. Check fixing area to make sure there is no risk of detachment.



Before using the equipment check for visible eventual damage. Never use a damaged equipment!



To prevent the risk of damaging the equipment, verify that the power supply voltage and frequency complies with the specifications indicated in the characteristics plate.



This equipment is supplied with an equipotential connecting terminal, in the upper part, which must be properly connected with the earthing circuit by a certified technician.



This equipment is part of an exhaust system, which is complemented by a ventilation motor and an element of command to which will be connected the light bulb. Other installations methods are not foreseen.



Only properly qualified and certified technicians may conduct the installation and maintenance of the equipment. The manufacturer is not responsible for damage resulting of maintenance and other interventions conducted by unqualified technicians.



Do not make fire under the Canopy.



**Always keep the equipment clean. Clean according to the recommendations supplied in this manual. Fire Hazard!**



**Risk of Burn Injuries! Do not open the oil drainage valve while the equipment is still hot.**



**This appliance can be used by children aged eight years and above and persons with reduced physical, sensory or mental capabilities or lack of experience and knowledge if they have been given supervision or instruction concerning use of the appliance in a safe way and understand the hazards involved;**



**Children must not be allowed to play with the equipment;**



**Cleaning and maintenance must not be conducted by children;**



**The air must not be discharged into a duct used to exhaust fumes from appliances burning gas or other fuels;**



**The minimum distance to be respected between the supporting surface for the cooking pots on the hob and the lowest part of the cooker hood is 80 to 100 cm;**



**A means of disconnection in accordance with installation regulations (switch or circuit breaker) must be provided on the fixed pipework;**

## 1.2. Purpose of Use

The Inclined and Rectangular Canopies were conceived to collect the vapours resulting from cooking. The manufacturer does not advise any other use, non compliance of this may compromise the safety of the equipment and the user.

The Canopies are meant for commercial use.

Do not use the equipment outside.

## 1.3. User Requirements

The equipment must be maintained out of reach of children, which must be supervised in order to assure they do not play with the equipment.

## 1.4. Recycling

Packaging material: Before first use remove all plastic protections from the equipment. All packaging and protection materials are recyclable.



**Verify the safe elimination of all plastic packaging. Maintain all packaging materials out of reach of children. Choking Hazard!**



The electric and electronic equipment contain materials that, when wrongly used, may danger human health and the environment.

Do not deposit any part or component of the equipment in domestic waste containers. Deposit them in industrial collecting centers, contact your supplier or local authorities for advice.

## 2.

### 2.1. General Characteristics:

Model	N° of Filters	Lighting		Motor	Package Dimensions WxDxH (mm)
		Number per Hood	Max Power (LED tube)	Power	
800x700x500	1	1x600	1x8W	150W	870x530x850
1000x700x500	2	1x600	1x8W	150W	1070x530x850
1200x700x500	2	1x600	1x8W	150W	1270x530x850
1400x700x500	3	1x600	1x8W	150W	1470x530x850
1600x700x500	3	1x1200	1x16W	370W	1670x530x850
1800x700x500	3	1x1500	1x24W	370W	1870x530x850
2000x700x500	4	1x1500	1x24W	370W	2070x530x850
2200x700x500	4	1x1500	1x24W	370W	2270x530x850
2400x700x500	4	2x600	2x8W	370W	2470x530x850
2600x700x500	4	2x600	2x8W	550W	2670x530x850
2800x700x500	5	2x600	2x8W	550W	2870x530x850
3000x700x500	6	2x1200	2x16W	550W	3070x530x850
800x900x500	1	1x600	1x8W	150W	870x530x1050
1000x900x500	2	1x600	1x8W	150W	1070x530x1050
1200x900x500	2	1x600	1x8W	150W	1270x530x1050
1400x900x500	3	1x600	1x8W	370W	1470x530x1050
1600x900x500	3	1x1200	1x16W	370W	1670x530x1050
1800x900x500	3	1x1500	1x24W	370W	1870x530x1050
2000x900x500	4	1x1500	1x24W	370W	2070x530x1050
2200x900x500	4	1x1500	1x24W	550W	2270x530x1050
2400x900x500	4	2x600	2x8W	550W	2470x530x1050
2600x900x500	4	2x600	2x8W	550W	2670x530x1050
1000x1100x500	2	1x600	1x8W	150W	1070x530x1250
1200x1100x500	2	1x600	1x8W	150W	1270x530x1250
1400x1100x500	3	1x600	1x8W	370W	1470x530x1250
1600x1100x500	3	1x1200	1x16W	370W	1670x530x1250
1800x1100x500	3	1x1500	1x24W	550W	1870x530x1250
2000x1100x500	4	1x1500	1x24W	550W	2070x530x1250
2200x1100x500	4	1x1500	1x24W	550W	2270x530x1250
2400x1100x500	4	2x600	2x8W	550W	2470x530x1050
2600x1100x500	4	2x600	2x8W	550W	2670x530x1050
1000x1400x500	2	1x600	1x8W	370W	1070x530x1250
1200x1400x500	2	1x600	1x8W	370W	1270x530x1250
1400x1400x500	3	1x600	1x8W	370W	1470x530x1250
1600x1400x500	3	1x1200	1x16W	550W	1670x530x1250
1800x1400x500	3	1x1500	1x24W	550W	1870x530x1250
2000x1400x500	4	1x1500	1x24W	550W	2070x530x1250
2200x1400x500	4	1x1500	1x24W	550W	2270x530x1250

- Stainless Steel Construction;
- Stainless Steel Filters 400x400x20 for the 700 depth.
- Stainless Steel Filters 400x500x20 for the 900/1100/1400 depths.
- Oil Extraction Valve;
- With LED lighting;
- With extraction motor;

## 2.2. Exploded View

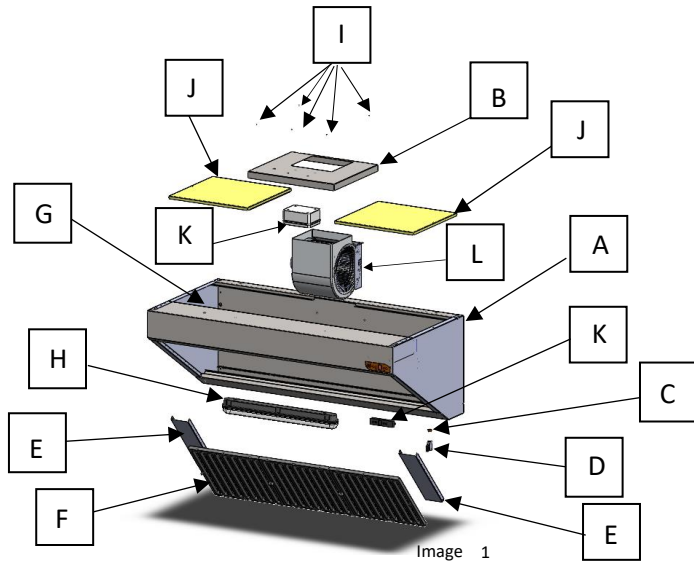

Letter	Description
A	Welded Canopy structure (according to the model)
B	Top Mid Motor Cover 700/900/1100/1400
C	Brass Bushing Ø25X9.5
D	Small Sphere Tap F/F 1/2
E	Filter Partition
F	Filter for Canopy 400x400x20 Filter for Canopy 400x500x20
G	Wire Hole Ø 14mm
H	Sealed Lighting 600/1200/1500 C/LAMP
I	One Hole Screw Ph 4,8x32mm + Screw Protection
J	Top Side Cover
K	Canopy Ventilation/Illumination Command 916 IR 008.2 w/cable 2mt
L	Motor DTM-7/7-4M 1/5 / DTM-9/9-4M 1/2 / DTM-9/9-4M 3/4

### 3. Installation

#### 3.1. Assembly Instructions:

- a. Remove the equipment from the wood structure and, after that, the stainless steel protection film carefully to avoid scratching the surface;
- b. Remove the filters and the partitions as indicated by the picture 2 (pull the filter immobilizer to release);



Image 2

- c. Mover a Hotte com auxílio de um carrinho de elevação de garfos, inserir os garfos por Move the Canopy with the aid of a fork lifter, insert the forks under the pallet and move, making sure the cargo is well balanced;  
Do not pull or push the equipment to avoid damage or the risk of falling on the ground;
- d. Assemble the extraction valve, as seen in image 3;

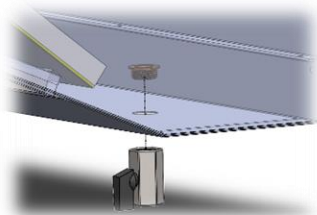

Image 3



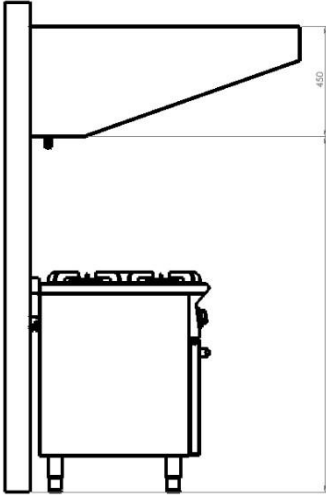

Image 4

- e. Place the Canopy over the stove for which is meant. Have in attention that the external dimensions of the Canopy must exceed the dimensions of the stove by a minimum of 200mm.
- f. The height of the lower part of the Canopy to the floor must be between 1850 and 2000 mm; the distance between the heating area and the lower part of the Canopy must be between 800 to 1000 mm.
- g. The supply and exhaust of air must be made through conducts destined exclusively to the Canopy and **must comply with applicable norms.**
- i. Mark the horizontal lines in the Wall and drill with the power drill to apply the bushings (not supplied);
- h. Fix the Canopy temporarily and mark the vertical lines in the wall and drill;
- j. **Fix the equipment so that it does not detach from the wall;**
- i. Respect all the rules concerning ventilation and kitchen equipment.

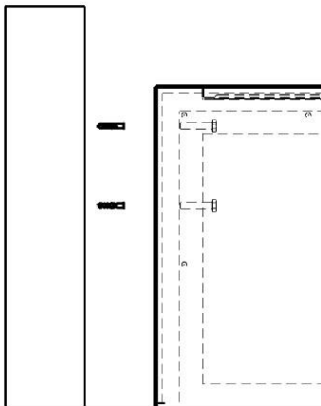

Image 5

HT04/1

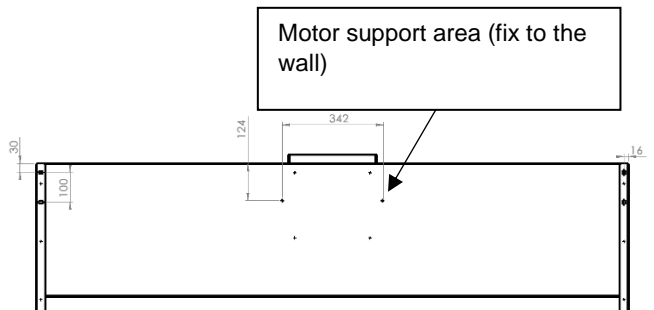

Image 6

**Optional;**

**Recommended to 1100 Depths**

- a. Tighten the mettalic bushings with the hook to the ceiling;
- b. Tighten the hooks with nuts in the upper corners of the Canopy, on the side opposing the wall;
- c. Lift the Canopy to the desired height and suspend by attaching the hooks previously applied;
- d. Adjust by screwing or unscrewing the nuts of the hooks applied in the front of the Canopy.

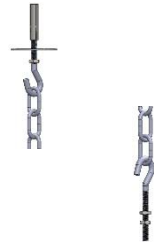
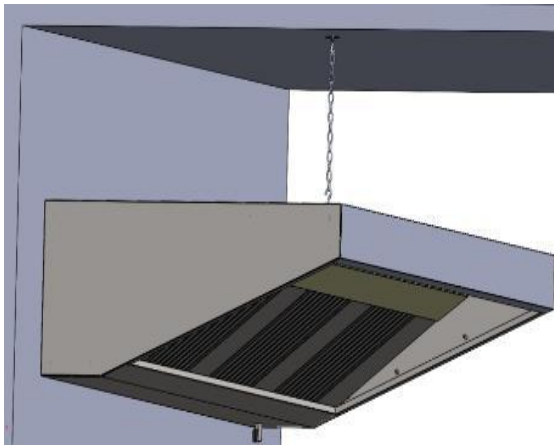

Image 7

### 3.2. Electrical Connection:

Verify that the informations indicated in the characteristics plate of the equipment match the voltage and frequency of the power supply.



Hotte de Parede / Campana Mural / Wall Hood / Hôte Murale 		
MODELO / MODEL / MODÈLE	POTÊNCIA / POWER / PUISSANCE	TENSÃO- FREQUÊNCIA / TENSION- FREQUENCIA POWER SUPPLY/TENSION- FREQUENCE
<b>2600x1100x500</b>	<b>550W</b>	<b>230V ~ 50/60Hz</b>
PNH BY PINHA Rua do Alto - Ap. 86 3750- 064 Aguada de Cima Telef. 234 690 190 Fax. 234 624 044 geral@pnh- bypinha.pt		Nº DE SÉRIE  2022/ ????? 

Image 8

**Connect the Equipment to a 6 Amp protection device (circuit breaker or fuse).**

**Ensure connection to ground circuit!**

Follow the norms in Effect in the country in which the installation occurs.



In the upper part of the equipment exists a connection terminal with the Symbol  that allows for the equipotential connection between several devices.

### 4. Electrical Scheme

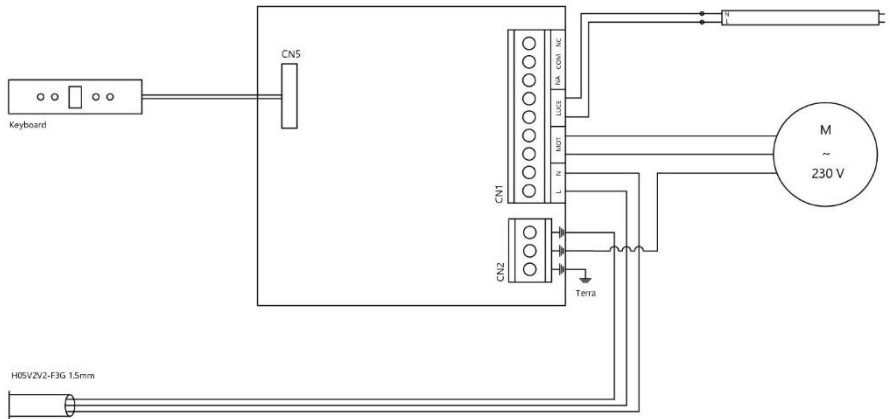

Image 9

## 5. Maintenance

### 5.1. Cleaning:

	Control	Frequency	Preparation	Execution
Mettalic Structure	Visual	Depending on use		Clean with a soft damp cloth, soaked in an alkaline detergent. In case of heavy soiling, or encrustation, use a wood or plastic scraper. <b><u>Do not direct water jets to the Canopy!</u></b>
Grease Filter	Visual	1x per week	Remove the filters from the Canopy	Clean with hot water or on the washing machine with an alkaline detergent.
Grease Drainage	Regular	1x per week	Open the drainage valve beneath the exhaust	Drain all the grease with the aid of a container. <b>Do not execute this operation while the equipment is hot!</b>
Bearings	-	25 000 hours (recomended)	-	<b>Authorised Repairer</b>

### 5.2. Spare Parts:

Reference	Description	Identification	Substitution
1MS0084005	Grease Filter	400x400	Remove the filter and substitute it for the new one.
1MS0084006		400x500	
1MS0127012	Sealed Lighting DSP- MP- <b>600</b> -1XT8-IP65- G13 W/LAMP	Consult the characteristics plate to identify maximum power; Confirm light dimensions on the light socket;	Release the stainless steel clips along the lighting socket. Turn the LED tube 90° and pull it down. Make sure the light complies with the connection diagram. Substitute the LED tube and replace the protection cover. <b>Attention! Make sure the power supply is disconnected before executing the operation.</b>
1MS0127013	Sealed Lighting DSP- MP- <b>1200</b> -1XT8-IP65- G13 W/LAMP		
1MS0127014	Sealed Lighting DSP- MP- <b>1500</b> -1XT8-IP65- G13 W/LAMP		
1MS0070004	Canopy Ventilation/Illumination Command 916 IR 008.2 w/ cable 2mt		<b>Authorised Repairer</b>
1MS0131004	Motor DTM-7/7-4M 1/5	Consult the characteristics plate to identify the motor's power;	<b>Authorised Repairer</b>
1MS0131005	Motor DTM-9/9-4M 1/2		
1MS0131006	Motor DTM-9/9-4M 3/4		
1MS0131008	Motor DTM 10/10 4M 3/4		

## 6. Warranty

- The equipment is warranted for a period of 12 months, from the date of purchase.
- The warranty is valid for manufacturing defects, be it of materials or the manufacturing process.
- Every time a anomaly is identified on the equipment, it must be returned promptly, along with the purchasing document or invoice.
- When the warranty is applied, the damaged parts will be replaced or repaired, according with the manufacturer decision. In case of substitution, the damaged parts must be returned to the manufacturer.
- The warranty excludes all defects and malfunctioning resulting from deficient intallation or misuse of the equipment.
- The equipment will lose warranty when a modification or alteration made by the user is identified.

**PNH**  
**RUA DO ALTO - VALE DO GROU – APARTADO 86**  
**3750 - 064 AGUADA DE CIMA**

**TEL. +351 234 622 889    FAX. +351 234 624 044**

**comercial@bypnh.pt    www.bypnh.pt/**